

Iso-RB EC

Sound-insulated inline centrifugal fans

Use

- Supply and exhaust ventilation systems in premises with high requirements to the noise level and with limited space for mounting.
- Possibility of space-restricted installation above suspended ceilings.
- Compatible with Ø 100–500 mm air ducts.



Air flow:
up to 7145 m³/h
1985 l/s



Power:
from 69 W



Noise level:
from 37 dBA



Design

- The fan casing is made of aluzinc.
- For easy installation and operation, the top cover of the fan is secured with a special lock.
- Heat- and sound insulation is made of non-combustible 50 mm mineral wool layer. To ensure better noise absorption, the inner surface of the insulation is made of a perforated metal sheet.
- The round connecting spigots are rubber sealed.



Speed control

- The fan speed is controlled with a 0–10 V control signal from the following sources:
 - integrated or external speed controller
 - controller with sensors
 - central BMS system.
- The control signal value changes depending on air temperature, pressure, smoke concentration and other parameters.
- During signal value change the fan with EC motor correspondingly changes the rotations speed and delivers required air volume to the ventilation system.
- The computer central building management systems (BMS) enable integration of several EC motors in network and precise individual operation control for each fan.

Mounting

- The round inline fans are designed for connection to round air ducts. The fans are installed at an air duct junction.
- The use of flexible connectors requires fixation of the fan on the building structure by means of supports, mounts or fixing brackets.
- The fan can be fixed in any position with respect to the air flow direction indicated by the arrow on the fan casing. While mounting the fan provide enough access for servicing and repair operations.

Motor

- High-efficient direct current EC motor with external rotor and backward curved blades.
- EC technology meets the up-to-date requirements to energy-saving and controllable ventilation and provides up to 35 % energy saving as compared to asynchronous motors.
- EC motor ensures totally controllable speed range for the fan and has integrated overheating protection with automatic restart.
- EC motor has no friction and wearing parts as capacitor und brushes. Instead a maintenance-free EC controller electronic circuit board is used.
- The impeller is dynamically balanced.
- The fan is compatible with 50 Hz and 60 Hz power mains and the maximum speed does not depend on power mains frequency.

Designation key

Series	Motor	Duct diameter [mm]	Options
Iso-RB	EC: synchronous electronically commutated motor	100; 125; 150; 160; 200; 250; 315; 355; 400; 450; 500	W1: power cable with mains plug

Accessories

Silencers	Filter boxes	Electric heaters	Water heaters	Backdraft air dampers	Air dampers	Speed controllers	Timers/Sensors
SD	KFBK / KFBT	EKH	WKH	VRV	VK / VKA	CDT E/0-10	TE(TI) / HSE(HSI) / LSE(LSI) / IRSE(IRSI)

Overall dimensions [mm]

Type	Ø D	B	B1	B2	H	L1	L2	Weight [kg]
Iso-RB EC 100	99	420	228	517	270	507	414	12
Iso-RB EC 125	124	420	228	517	270	507	414	12
Iso-RB EC 150	149	420	228	517	270	507	414	12
Iso-RB EC 160	159	420	228	517	270	507	414	12
Iso-RB EC 200	198	551	374	648	328	646	553	20
Iso-RB EC 250	248	665	487	762	371	709	616	27
Iso-RB EC 315	313	807	600	904	505	818	737	47
Iso-RB EC 355	354	807	600	904	505	818	737	47
Iso-RB EC 400	399	807	600	904	505	818	737	47
Iso-RB EC 450	449	885	670	982	580	886	805	60
Iso-RB EC 500	499	1049	800	1146	660	1079	998	86

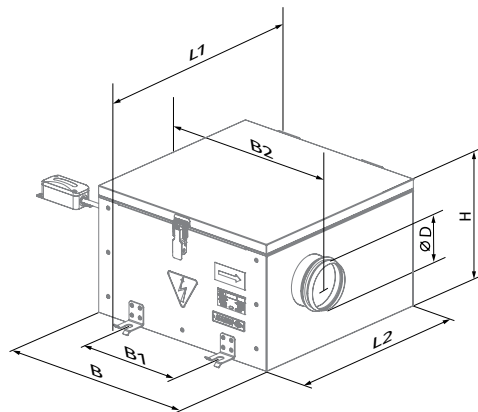

Technical data

Parameters	Iso-RB EC 100	Iso-RB EC 125	Iso-RB EC 150
Voltage [V/50 (60) Hz]	1 ~ 230	1 ~ 230	1 ~ 230
Power [W]	69	78	81
Current [A]	0.55	0.59	0.61
Maximum air flow [m ³ /h (l/s)]	341 (95)	444 (123)	495 (138)
RPM [min ⁻¹]	3270	3270	3270
Sound pressure level at 3 m distance [dBA]	37	39	40
Transported air temperature [°C]	-25...+55	-25...+55	-25...+55
IP rating	IPX4	IPX4	IPX4
Motor IP rating	IP44	IP44	IP44
SEC class	B	B	B
ErP	2018	2018	2018

ISO-RB EC 100

Sound power level, A-weighted	Total	Octave frequency bands [Hz]								LpA 3 m	LpA 1 m
		63	125	250	500	1000	2000	4000	8000		
L _{WA} to inlet [dBA]	65	51	59	63	54	50	44	44	34	45	55
L _{WA} to outlet [dBA]	83	68	78	80	75	61	53	55	47	63	73
L _{WA} to environment [dBA]	57	42	47	53	53	44	43	42	41	37	47

ISO-RB EC 125

Sound power level, A-weighted	Total	Octave frequency bands [Hz]								LpA 3 m	LpA 1 m
		63	125	250	500	1000	2000	4000	8000		
L _{WA} to inlet [dBA]	66	51	60	64	55	51	44	44	34	46	56
L _{WA} to outlet [dBA]	85	70	80	82	77	63	54	57	48	65	75
L _{WA} to environment [dBA]	59	44	49	55	55	46	45	44	43	39	49

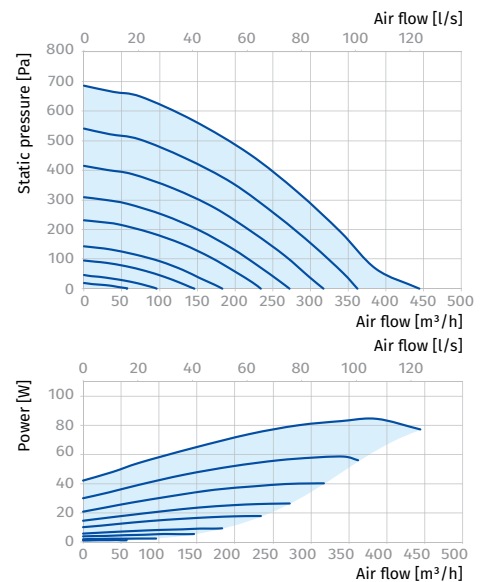
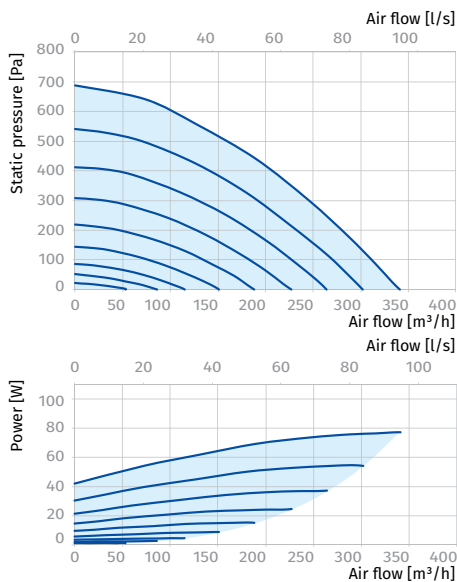
ISO-RB EC 150

Sound power level, A-weighted	Total	Octave frequency bands [Hz]								LpA 3 m	LpA 1 m
		63	125	250	500	1000	2000	4000	8000		
L _{WA} to inlet [dBA]	71	55	65	69	59	55	48	48	37	50	60
L _{WA} to outlet [dBA]	87	72	82	84	79	64	56	58	49	67	77
L _{WA} to environment [dBA]	60	43	51	58	53	43	42	40	40	40	50

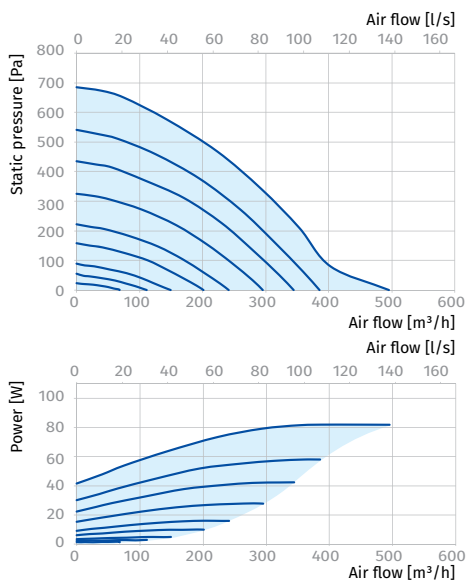

Parameters	Iso-RB EC 160	Iso-RB EC 200	Iso-RB EC 250	Iso-RB EC 315
Voltage [V/50 (60) Hz]	1 ~ 230	1 ~ 230	1 ~ 230	1 ~ 230
Power [W]	85	111	164	531
Current [A]	0.76	0.88	1.32	2.32
Maximum air flow [m³/h (l/s)]	454 (126)	740 (206)	1097 (305)	3053 (848)
RPM [min⁻¹]	3600	2400	2800	2360
Sound pressure level at 3 m distance [dBA]	40	42	45	47
Transported air temperature [°C]	-25...+55	-25...+55	-25...+55	-25...+55
IP rating	IPX4	IPX4	IPX4	IPX4
Motor IP rating	IP44	IP44	IP44	IP54
SEC class	B	B	B	-
ErP	2018	2018	2018	2018

ISO-RB EC 160

Sound power level, A-weighted	Total	Octave frequency bands [Hz]								LpA 3 m	LpA 1 m
		63	125	250	500	1000	2000	4000	8000		
LWA to inlet [dBA]	70	55	64	68	59	54	47	47	37	50	60
LWA to outlet [dBA]	90	74	83	87	82	67	58	60	51	69	79
LWA to environment [dBA]	60	43	51	58	53	43	42	40	40	40	50

ISO-RB EC 200

Sound power level, A-weighted	Total	Octave frequency bands [Hz]								LpA 3 m	LpA 1 m
		63	125	250	500	1000	2000	4000	8000		
LWA to inlet [dBA]	70	54	64	68	58	54	47	47	36	49	59
LWA to outlet [dBA]	80	65	75	77	72	59	51	53	45	60	70
LWA to environment [dBA]	63	39	46	62	52	46	45	35	34	42	52

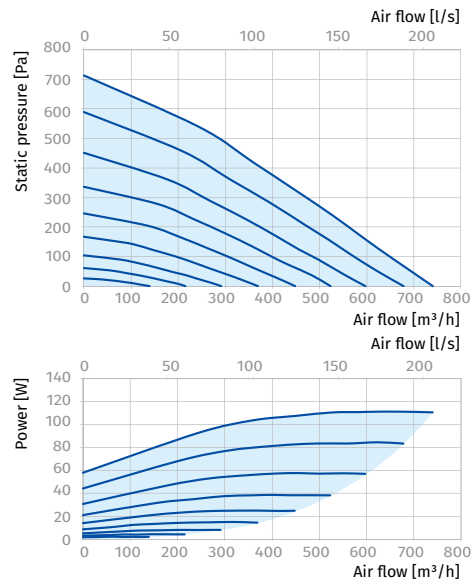
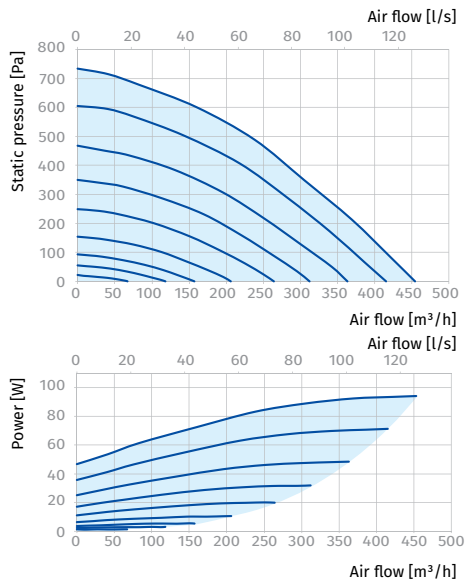

ISO-RB EC 250

Sound power level, A-weighted	Total	Octave frequency bands [Hz]								LpA 3 m	LpA 1 m
		63	125	250	500	1000	2000	4000	8000		
LWA to inlet [dBA]	77	60	70	75	64	59	52	52	40	56	66
LWA to outlet [dBA]	81	67	77	79	74	60	52	55	46	61	71
LWA to environment [dBA]	65	46	60	63	55	48	33	33	34	45	55

ISO-RB EC 315

Sound power level, A-weighted	Total	Octave frequency bands [Hz]								LpA 3 m	LpA 1 m
		63	125	250	500	1000	2000	4000	8000		
LWA to inlet [dBA]	84	77	80	79	75	68	64	62	60	64	74
LWA to outlet [dBA]	89	79	79	78	82	80	82	79	75	68	78
LWA to environment [dBA]	67	54	55	66	57	50	52	51	52	47	57

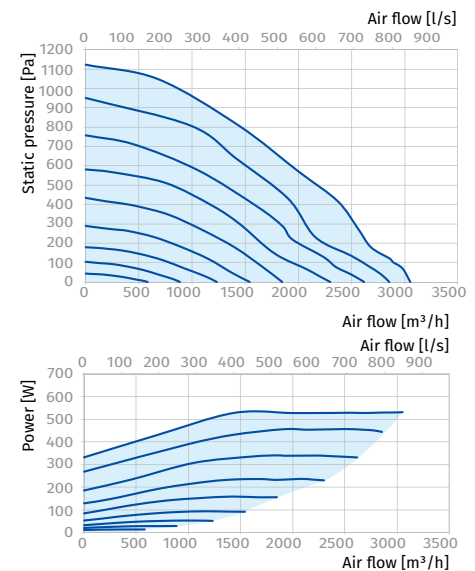
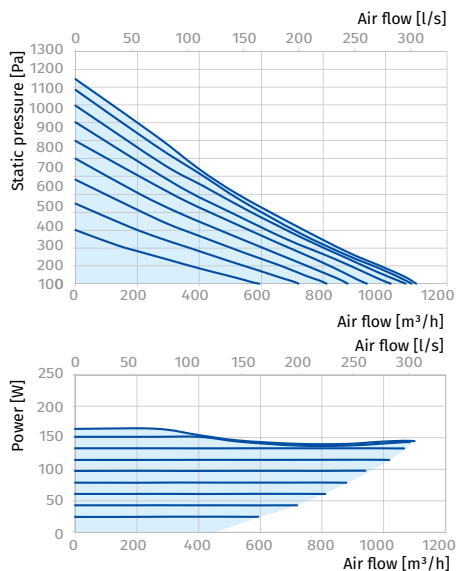

SOUND-INSULATED INLINE FANS

Parameters	Iso-RB EC 355	Iso-RB EC 400	Iso-RB EC 450	Iso-RB EC 500
Unit voltage [V/50 (60) Hz]	1 ~ 230	1 ~ 230	1 ~ 230	1 ~ 230
Power [W]	527	513	1200	752
Current [A]	2.31	2.25	1.95	3.42
Maximum air flow [m ³ /h (l/s)]	3417 (949)	3633 (1009)	5620 (1561)	7145 (1985)
RPM [min ⁻¹]	2360	2360	2580	1440
Sound pressure level at 3 m distance [dBA]	50	51	54	56
Transported air temperature [°C]	-25...+55	-25...+55	-25...+55	-25...+55
IP rating	IPX4	IPX4	IPX4	IPX4
Motor IP rating	IP54	IP54	IP54	IP54
SEC class	-	-	-	-
ErP	2018	2018	2018	2018

ISO-RB EC 355

Sound power level, A-weighted	Total	Octave frequency bands [Hz]								LpA 3 m	LpA 1 m
		63	125	250	500	1000	2000	4000	8000		
LWA to inlet [dBA]	89	82	85	84	80	72	68	66	64	69	79
LWA to outlet [dBA]	91	81	81	80	84	82	84	81	77	70	80
LWA to environment [dBA]	70	57	58	69	60	53	55	54	55	50	60

ISO-RB EC 400

Sound power level, A-weighted	Total	Octave frequency bands [Hz]								LpA 3 m	LpA 1 m
		63	125	250	500	1000	2000	4000	8000		
LWA to inlet [dBA]	86	67	79	84	72	67	58	58	45	65	75
LWA to outlet [dBA]	90	74	85	87	82	66	58	60	51	69	79
LWA to environment [dBA]	72	66	68	66	57	48	35	37	37	51	61

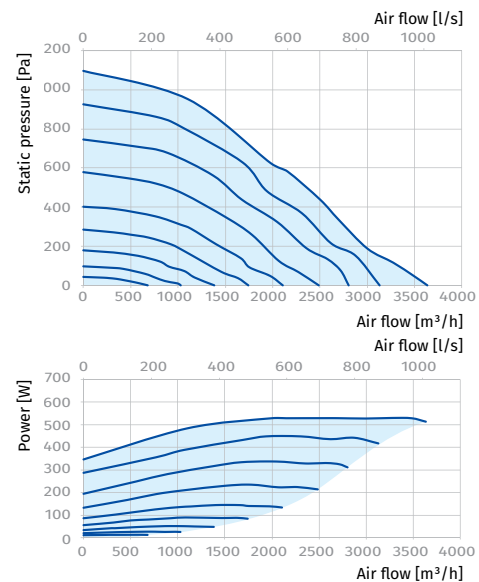
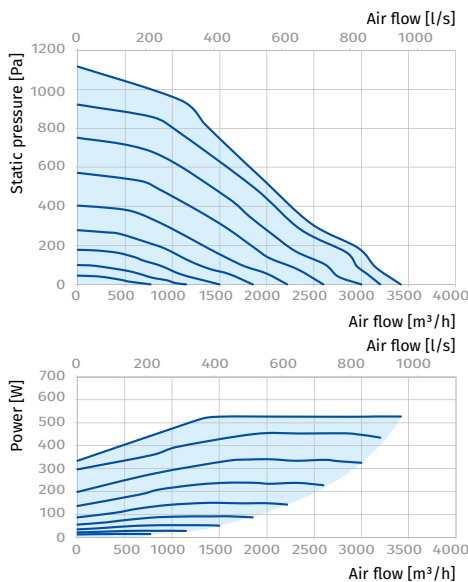

ISO-RB EC 450

Sound power level, A-weighted	Total	Octave frequency bands [Hz]								LpA 3 m	LpA 1 m
		63	125	250	500	1000	2000	4000	8000		
LWA to inlet [dBA]	85	66	78	83	71	66	57	57	44	64	74
LWA to outlet [dBA]	92	76	87	89	84	69	59	62	52	71	81
LWA to environment [dBA]	75	61	71	72	58	55	46	44	39	54	64

ISO-RB EC 500

Sound power level, A-weighted	Total	Octave frequency bands [Hz]								LpA 3 m	LpA 1 m
		63	125	250	500	1000	2000	4000	8000		
LWA to inlet [dBA]	88	69	81	86	74	68	59	59	46	67	77
LWA to outlet [dBA]	94	78	89	91	86	70	61	63	53	73	83
LWA to environment [dBA]	77	62	73	74	60	57	47	45	40	56	66

