

FRESHBOX 100 WIFI

SINGLE-ROOM AIR HANDLING UNITS

Features

- Efficient solution for supply and exhaust ventilation of enclosed spaces.
- Electric preheater or reheater modification available for cold climate conditions.
- Heat exchanger with an enthalpy membrane modification available for humid and hot climate conditions.
- Low-energy EC motors.
- Silent operation.
- Upgradeable with an exhaust duct to provide air extraction from the bathroom.
- Easy installation.
- Compact size.
- Controlled by Android or iOS smartphone or tablet over Wi-Fi.



Air flow:
up to 100 m³/h
28 l/s



Heat recovery efficiency:
up to 98 %



Design

- Polymer coated metal casing decorated with an acrylic front panel. Heat and noise insulation is ensured by a layer of 10 mm cellular synthetic rubber.
- The front panel provides convenient access for filter maintenance and has a lock for extra security.
- The unit has two Ø 100 mm pipes for fresh air intake and stale air extraction outside. The third Ø 100 mm pipe (included in the scope of delivery) can be additionally fitted to the unit to connect the exhaust air duct from the bathroom.

Motors

- The units feature efficient electronically commutated (EC) motors with an external rotor and impellers with forward curved blades. These state-of-the-art motors are the most advanced solution in energy efficiency today.
- EC motors are characterised with high performance and optimum control across the entire speed range. In addition to that the efficiency of electronically commutated motors reaches very impressive levels of up to 90 %.

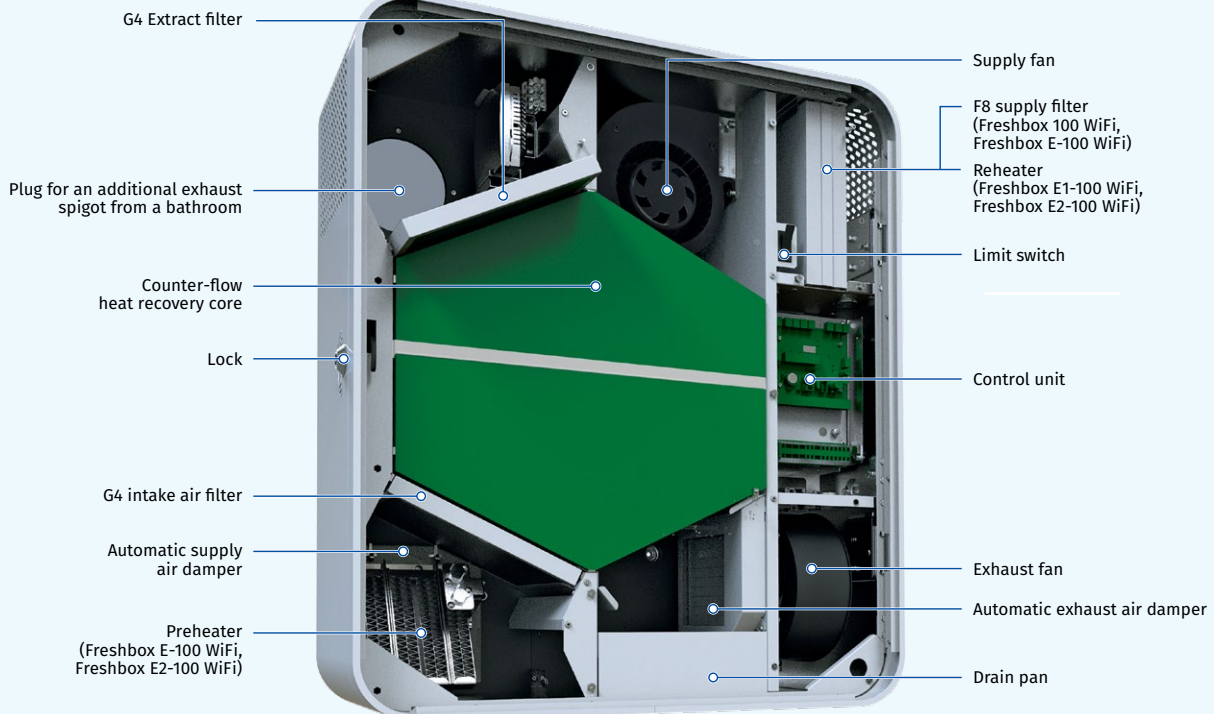

Designation key

Series	Heater	Rated air flow [m ³ /h]	Heat exchanger core type	Control
Freshbox	_: no heater E: preheating E1: reheating E2: preheating and reheating	— 100	_: heat recovery ERV: energy recovery	WiFi: sensor control panel and Wi-Fi communication

FRESHBOX 100 WIFI

SINGLE-ROOM AIR HANDLING UNITS

Air dampers

- The unit is equipped with supply and exhaust air dampers which activate automatically to prevent drafts while the unit is off.

Air filtration

- Freshbox 100 WiFi, Freshbox E-100 WiFi:** supply air cleaning is provided by the G4 and F8 filters. To meet more stringent air purity requirements the F8 filter can be replaced with an H13 or F8 carbon filter (purchased separately). Exhaust air is cleaned by the filter G4.
- Freshbox E1-100 WiFi, Freshbox E2-100 WiFi:** the built-in G4 supply filter and G4 extract filter provide air filtration.

Operating principle

- The cold outdoor air** passes through the filters and the heat exchanger and then is delivered to the serviced space by the supply centrifugal fan.
- Warm stale air from indoors** passes through the filter and the heat exchanger and is discharged outdoors by the centrifugal fan.
- The supply and exhaust air** flows are fully separated which helps eliminate the possibility of odour or microbial transfer between the streams.

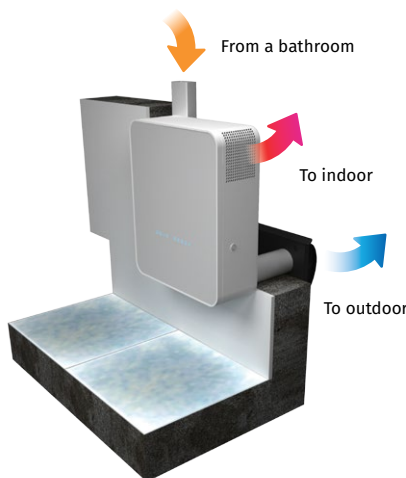
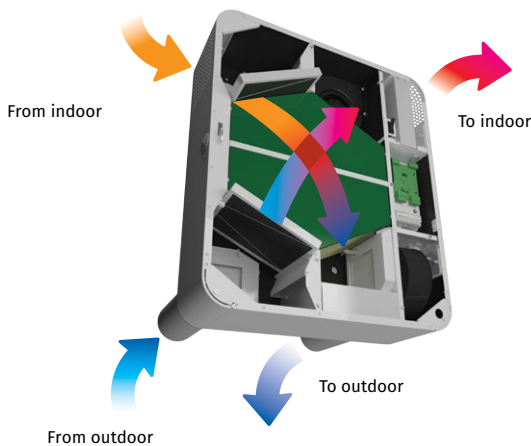

Operating principle with extra spigot for bathroom exhaust ventilation

Heat and energy recovery

- The **Freshbox 100 WiFi** units are equipped with a counter-flow heat recovery core with a polystyrene core.
 - In the cold season** the exhaust air heat is captured and transferred to the supply air stream which reduces the ventilation-generated heat losses. Some condensate may form during heat recovery. The condensate is collected in the drain pan and is removed from the exhaust air duct.
 - In the warm season** the intake air heat is transferred to the extract air stream. This allows for a considerable reduction of the supply air temperature which, in turn, reduces the air conditioning load.
- The **Freshbox 100 ERV WiFi** units are equipped with a counter-flow energy recovery core with an enthalpy membrane at the core.
 - In the cold season** the exhaust air heat and moisture are transferred to the supply air stream through the enthalpy membrane reducing the heat losses through ventilation.
 - In warm season** the heat and humidity of the outdoor air is absorbed by extract air flow through the enthalpy membrane. This way the supply air temperature and humidity decreases and heat recovery reduces operation loads for the air conditioner.

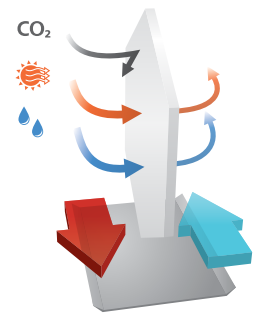
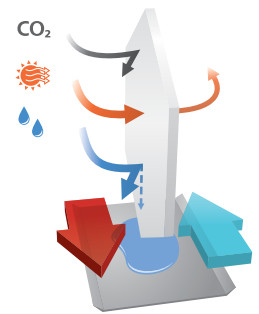

Heaters

PREHEATING

- Freshbox E-100 WiFi, Freshbox E2-100 WiFi** units are equipped with an electric preheater for freeze protection of the heat exchanger.

REHEATING

- Freshbox E1-100 WiFi, Freshbox E2-100 WiFi** units feature an electric reheater to raise the supply air temperature as necessary.

Freeze protection

- Freshbox 100 WiFi** features an exhaust air temperature sensor downstream of the heat exchanger which disables the supply fan to let the warm extract air warm up the heat exchanger. After that the supply fan is turned on and the unit reverts to the normal operation mode.
- Overheating protection for **Freshbox E-100 WiFi** and **Freshbox E2-100 WiFi** is implemented with a preheater.

FRESHBOX 100 WiFi

SINGLE-ROOM AIR HANDLING UNITS

Control

- The unit is equipped with a control panel.
- The remote control is supplied as standard
- Wi-Fi communication.



AUTOMATIC FUNCTIONS

	Freshbox 100 WiFi Freshbox E-100 WiFi	Freshbox E1-100 WiFi Freshbox E2-100 WiFi
Speed selection	•	•
Filter replacement indication	•	•
Alarm indication	•	•
Speed setup	•	•
Timer	•	•
Week scheduler	•	•
Reheater enabled/disabled		•
Supply air temperature setup		•
Control with the mobile application Android / iOS	•	•



Download
Android application
Blauberg Freshbox



Download
iOS application
Blauberg Freshbox

REMOTE CONTROL

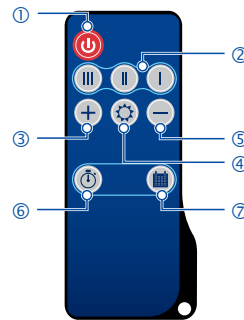

- 1 Turning unit on/off
- 2 Speed selection (Min/Mid/Max)
- 3 Increasing temperature set point for the reheater (available for the models with a reheater)
- 4 Turning reheater on/off (available for the models with a reheater)
- 5 Decreasing temperature set point for the reheater (available for the models with a reheater)
- 6 Turning timer on/off
- 7 Activation/deactivation of the scheduled operation mode

CONTROL PANEL

- ON/OFF button
- Speed changeover (down)
- Speed changeover (up)
- Weekly schedule
- Connection to WiFi
- Filter replacement indication
- Alarm indication

Technical data

Parameters	Freshbox 100 WiFi					Freshbox 100 ERV WiFi					Freshbox E-100 WiFi					Freshbox E-100 ERV WiFi				
	I	II	III	IV	V	I	II	III	IV	V	I	II	III	IV	V	I	II	III	IV	V
Speed																				
Voltage [V / 50 (60) Hz]	1~ 110-240										1~ 230									
Max. power without heater(s) [W]	20	23	29	37	53	20	23	29	37	53	20	23	29	37	53	20	23	29	37	53
Preheater power consumption [W]											700					700				
Reheater power consumption [W]																				
Max. current consumption without heater(s) [A]	0.4																			
Max. current consumption with heater(s) [A]											3.6					3.6				
Maximum air flow [m³/h (l/s)]	30 (8)	44 (12)	60 (17)	75 (21)	100 (28)	30 (8)	44 (12)	60 (17)	75 (21)	100 (28)	30 (8)	44 (12)	60 (17)	75 (21)	100 (28)	30 (8)	44 (12)	60 (17)	75 (21)	100 (28)
RPM [min⁻¹]	max 2200																			
Sound pressure level at 3 m [dBA]	13	20	27	33	39	13	20	27	33	39	13	20	27	33	39	13	20	27	33	39
Transported air temperature [°C]	-15...+40																			
Casing material	polymer coated steel																			
Insulation thickness [mm]	10																			
Extract filter	G4																			
Supply filter	G4 + F8 (Option: F8 Carbon; H13)																			
Connected air duct diameter [mm]	100																			
Weight [kg]	31																			
Heat recovery efficiency [%]*	98	95	92	90	89	96	94	89	85	83	98	95	92	90	89	96	94	89	85	83
Heat recovery core type	counter-flow																			
Heat exchanger material	polystyrene					enthalpic membrane					polystyrene					enthalpic membrane				
SEC class	A																			

*Heat recovery efficiency is specified in compliance with EN 13141-8.

FRESHBOX 100 WIFI

SINGLE-ROOM AIR HANDLING UNITS

Parameters	Freshbox E1-100 WiFi					Freshbox E1-100 ERV WiFi					Freshbox E2-100 WiFi					Freshbox E2-100 ERV WiFi				
	I	II	III	IV	V	I	II	III	IV	V	I	II	III	IV	V	I	II	III	IV	V
Speed																				
Voltage [V / 50 (60) Hz]	1~230																			
Max. power without heater(s) [W]	20	23	29	37	53	20	23	29	37	53	20	23	29	37	53	20	23	29	37	53
Preheater power consumption [W]	-					-					700					700				
Reheater power consumption [W]	350																			
Max. current consumption without heater(s) [A]	0.4																			
Max. current consumption with heater(s) [A]	1.94										5.2									
Maximum air flow [m³/h (l/s)]	30 (8)	44 (12)	60 (17)	75 (21)	100 (28)	30 (8)	44 (12)	60 (17)	75 (21)	100 (28)	30 (8)	44 (12)	60 (17)	75 (21)	100 (28)	30 (8)	44 (12)	60 (17)	75 (21)	100 (28)
RPM [min⁻¹]	max 2200																			
Sound pressure level at 3 m [dBA]	13	20	27	33	39	13	20	27	33	39	13	20	27	33	39	13	20	27	33	39
Transported air temperature [°C]	-15...+40																			
Casing material	polymer coated steel																			
Insulation thickness [mm]	10																			
Extract filter	G4																			
Supply filter	G4																			
Connected air duct diameter [mm]	100																			
Weight [kg]	31																			
Heat recovery efficiency [%]*	98	95	92	90	89	96	94	89	85	83	98	95	92	90	89	96	94	89	85	83
Heat recovery core type	counter-flow																			
Heat exchanger material	polystyrene					enthalpic membrane					polystyrene					enthalpic membrane				
SEC class	A																			

*Heat recovery efficiency is specified in compliance with EN 13141-8.

Sound-power level, A - weighted	Total	Octave frequency band [Hz]								Sound pressure level at 3 m, A-filter applied	Sound pressure level at 1 m, A-filter applied
		63	125	250	500	1000	2000	4000	8000		
LwA to environment [dBA]	49	45	40	44	38	33	29	27	22	28	38

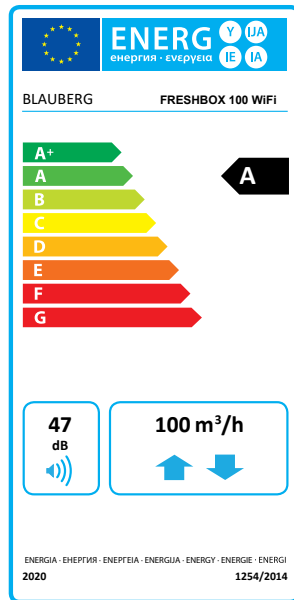
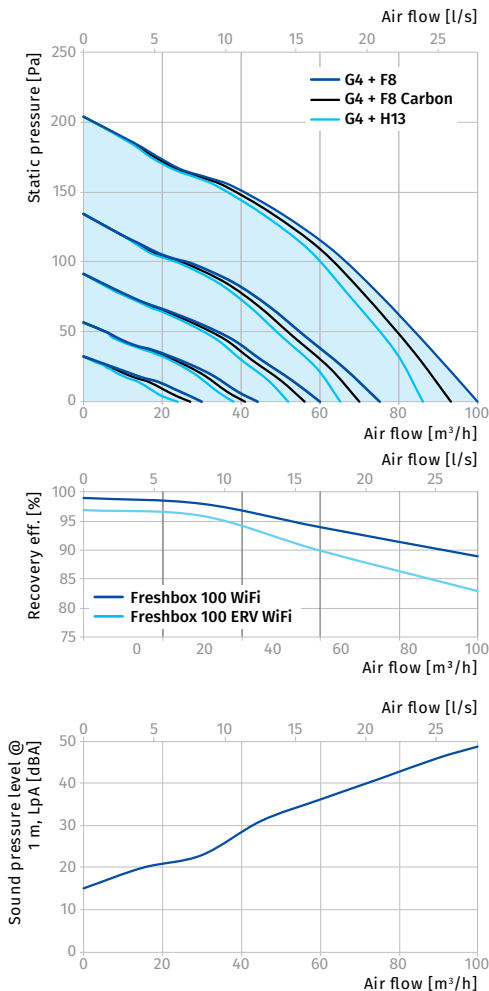

Overall dimensions [mm]

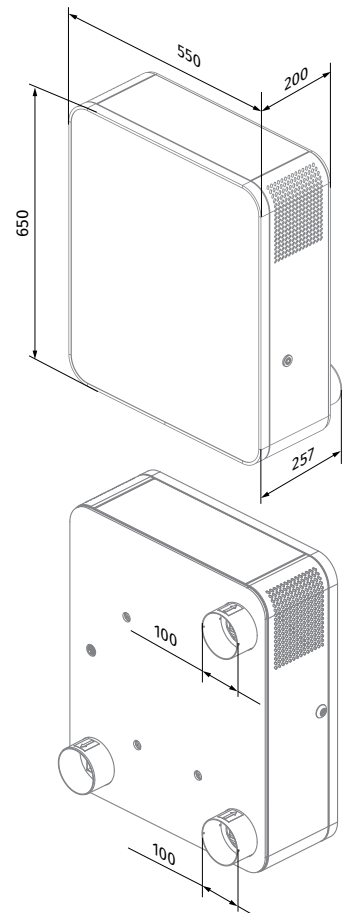

FRESHBOX 100 WIFI

SINGLE-ROOM AIR HANDLING UNITS

Mounting example

Each space requiring ventilation is equipped with one or several Freshbox 100 WiFi units. A single unit is capable to ensure efficient ventilation in spaces with floor area up to 75 m².

Freshbox 100 WiFi units can be upgraded with a bathroom exhaust air duct. To enable such a configuration the units can be additionally equipped with the optional Ø 100 mm spigot (supplied as standard).

FRESHBOX 100 WIFI DEPLOYMENT IN A COMPACT RESIDENTIAL SPACE

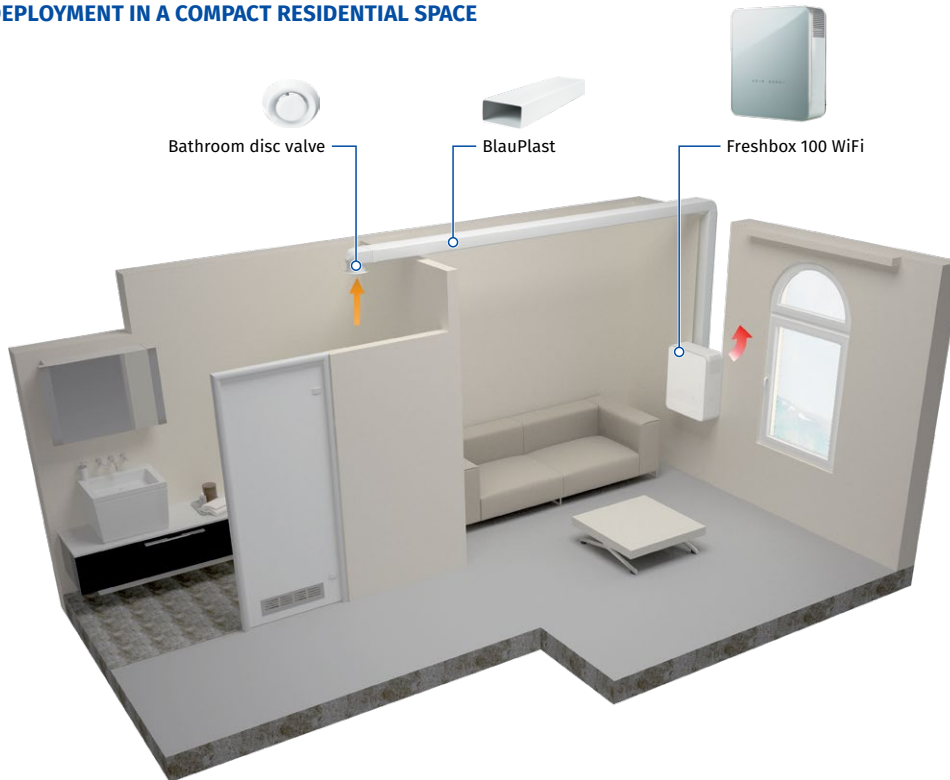

FRESHBOX 100 WIFI MOUNTING EXAMPLE IN THE OFFICE

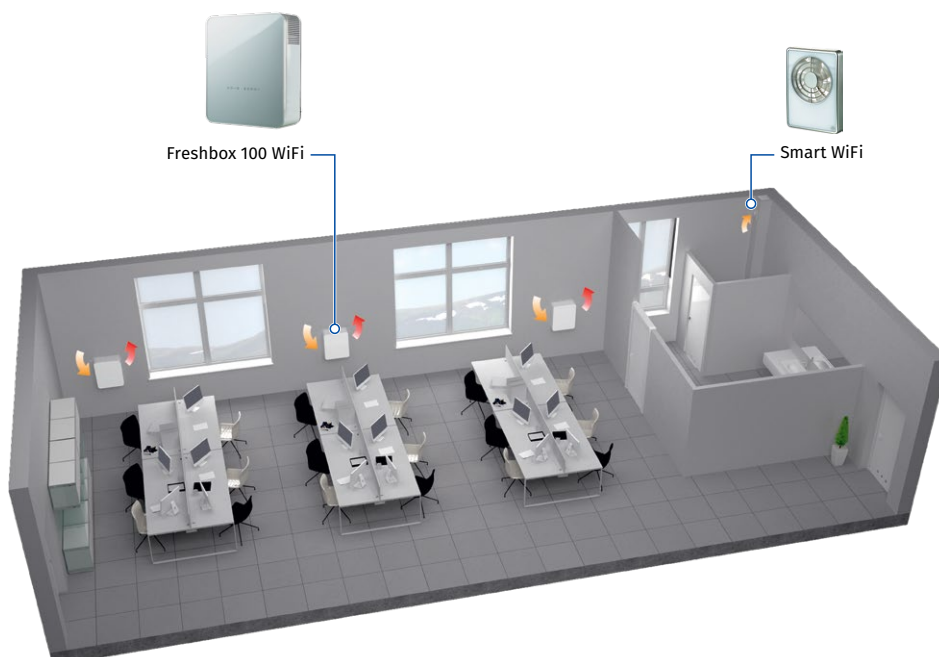

FRESHBOX 100 WIFI

SINGLE-ROOM AIR HANDLING UNITS

Accessories

Name		Description
MS Freshbox 100 chrome		Mounting kit: • Two \varnothing 100 mm air ducts, 500 mm long • Ventilation outer hood made of polished steel • Cardboard template
MS Freshbox 100 white		Mounting kit: • Two \varnothing 100 mm air ducts, 500 mm long • Ventilation outer hood, painted white • Cardboard template
AH Freshbox 100 chrome		Ventilation outer hood made of polished steel
AH Freshbox 100 white		Ventilation outer hood, painted white
EH Freshbox 100		Heater to prevent condensate freezing in the drain pipe and outer ventilation hood
FP 193x158x18 G4 PPI		G4 panel filter
FP 193x158x47 F8		F8 panel filter
FP 193x158x47 F8 C		F8 carbon panel filter
FP 193x158x47 H13		H13 HEPA panel filter
HR-S		Humidity sensor
CD-1		CO ₂ sensor with LED CO ₂ indication and a sensor button for operation mode selection
CD-2		CO ₂ sensor